

Name: _____

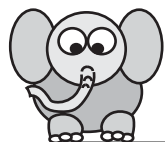

Letter **a** Tracing!

Tracing row 1: A horizontal line with a dashed midline and a solid bottom line. Two large, light grey lowercase 'a's are positioned on the line for tracing. A grey vertical bar is on the right side.



Tracing row 2: A horizontal line with a dashed midline and a solid bottom line. Three medium-sized, light grey lowercase 'a's are positioned on the line for tracing. A grey vertical bar is on the right side.



Tracing row 3: A horizontal line with a dashed midline and a solid bottom line. Four small, light grey lowercase 'a's are positioned on the line for tracing. A grey vertical bar is on the right side.



Tracing row 4: A horizontal line with a dashed midline and a solid bottom line. Six very small, light grey lowercase 'a's are positioned on the line for tracing. A grey vertical bar is on the right side.



Tracing row 5: A horizontal line with a dashed midline and a solid bottom line. Seven tiny, light grey lowercase 'a's are positioned on the line for tracing. A grey vertical bar is on the right side.

Name: _____

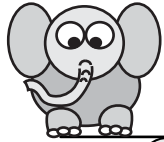

Letter **b** Tracing!

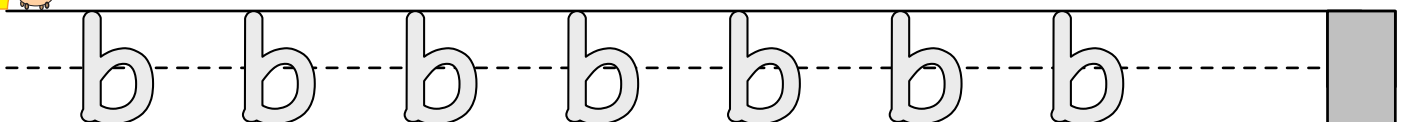
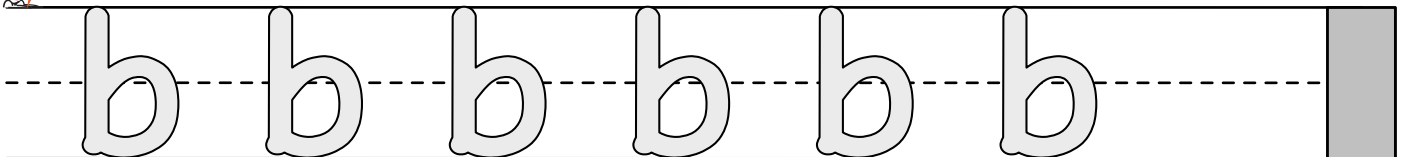
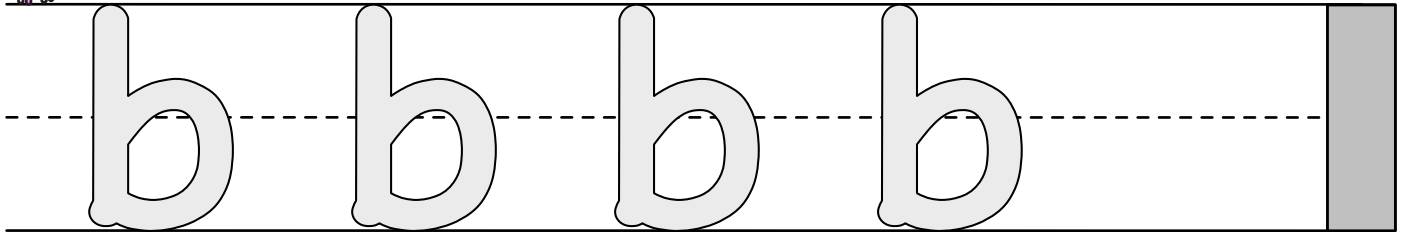
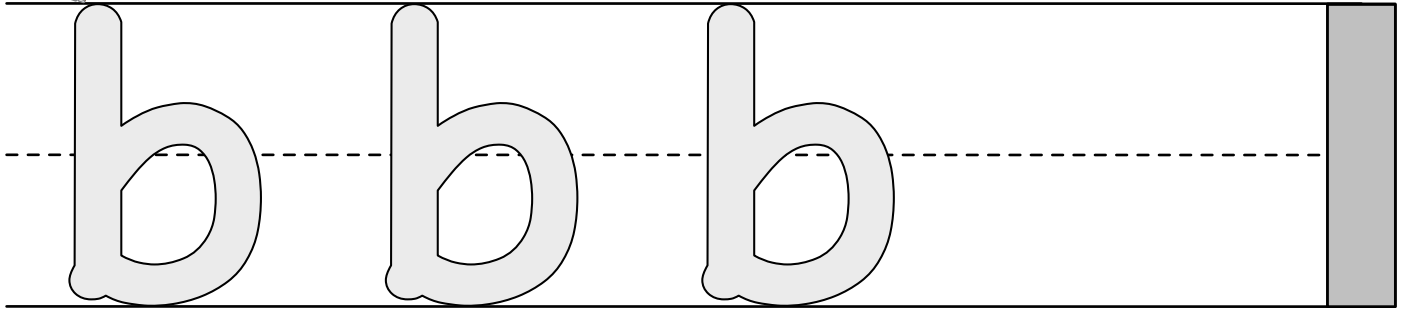
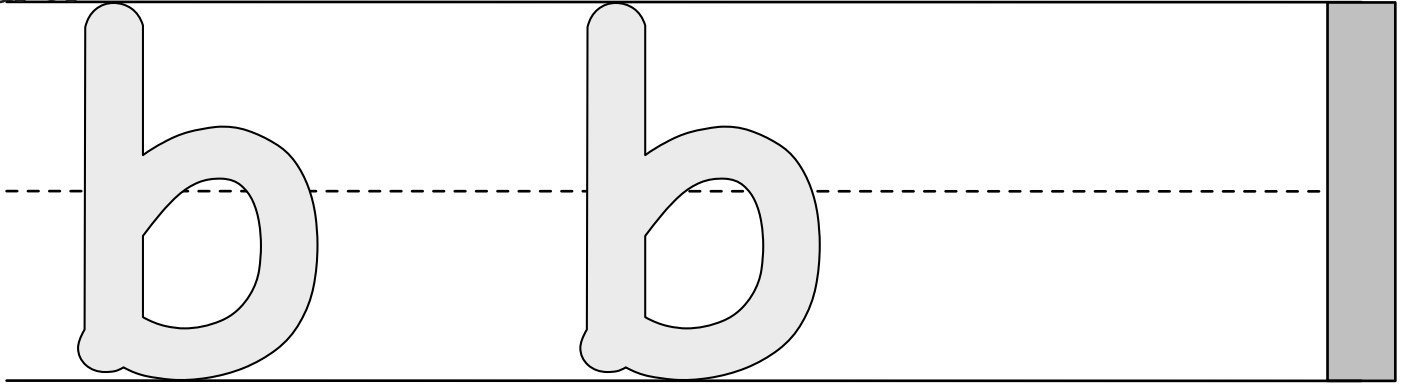

Name: _____

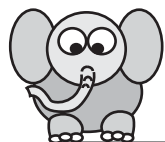

Letter C Tracing!

Tracing row 1: A horizontal line with a dashed midline and a solid bottom line. Two large, light grey uppercase 'C' characters are positioned between the lines for tracing.



Tracing row 2: A horizontal line with a dashed midline and a solid bottom line. Three medium-sized, light grey uppercase 'C' characters are positioned between the lines for tracing.



Tracing row 3: A horizontal line with a dashed midline and a solid bottom line. Four small, light grey uppercase 'C' characters are positioned between the lines for tracing.



Tracing row 4: A horizontal line with a dashed midline and a solid bottom line. Six very small, light grey uppercase 'C' characters are positioned between the lines for tracing.



Tracing row 5: A horizontal line with a dashed midline and a solid bottom line. Seven tiny, light grey uppercase 'C' characters are positioned between the lines for tracing.

Name: _____

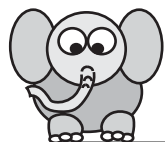

Letter **d** Tracing!

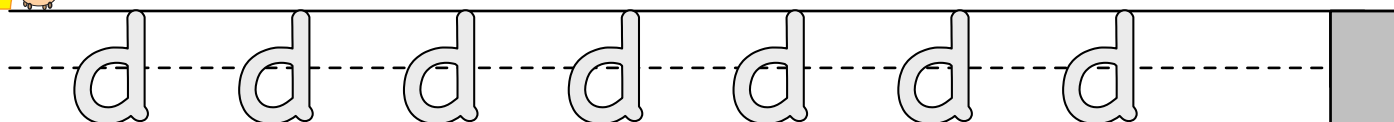
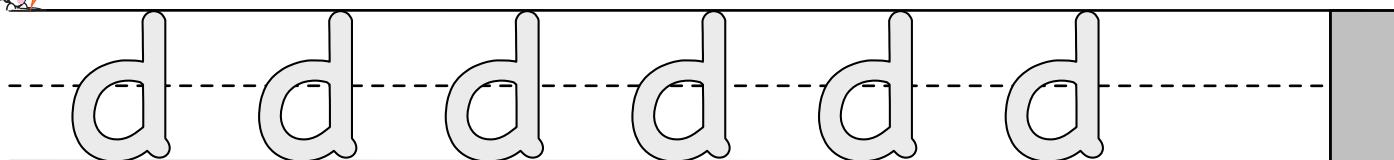
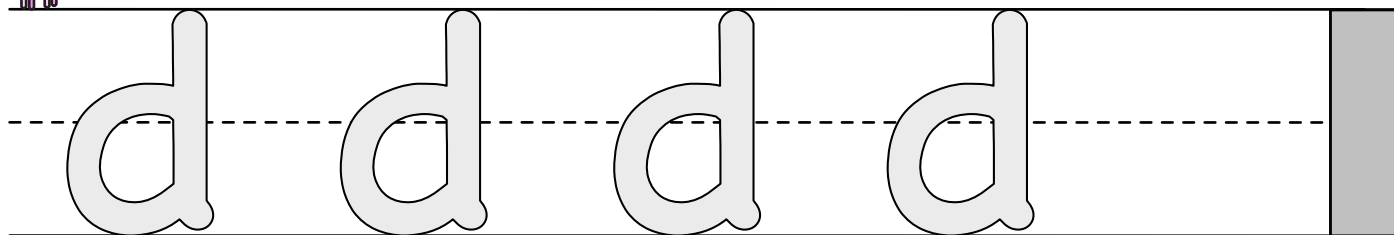
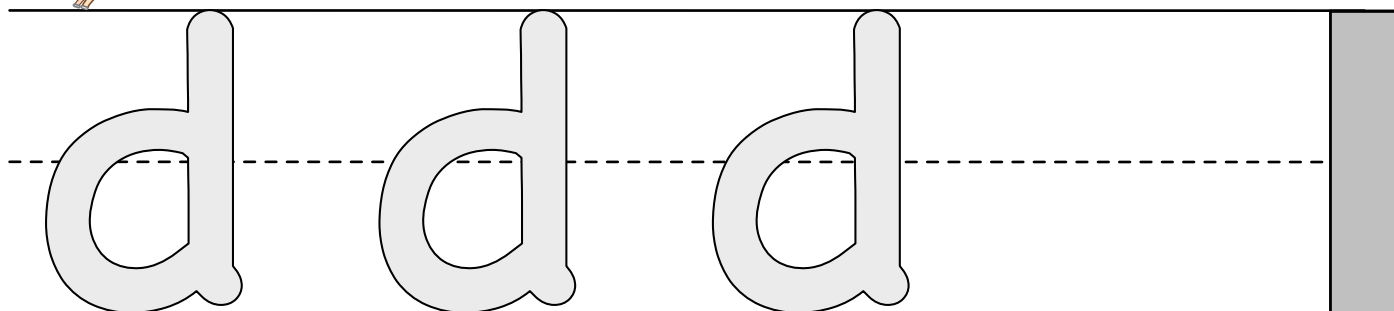
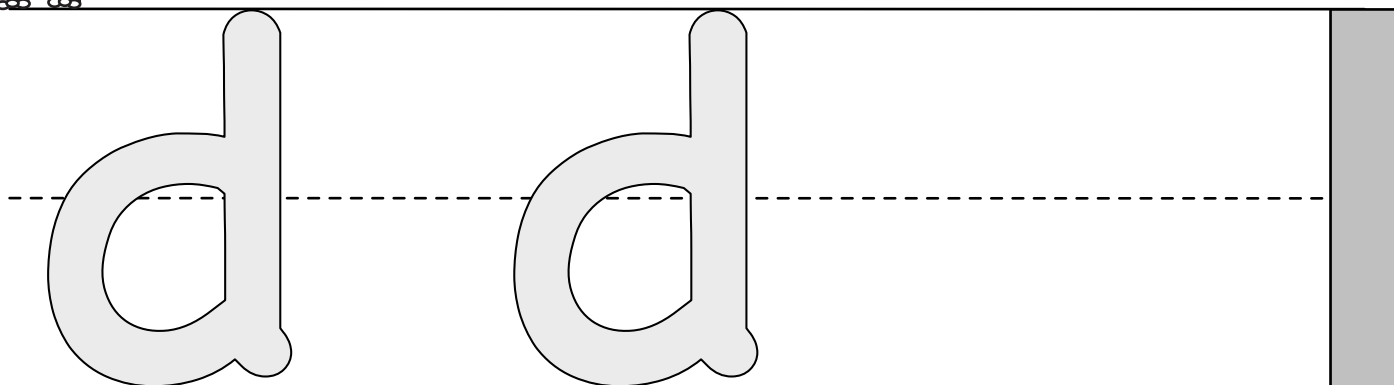

Name: _____

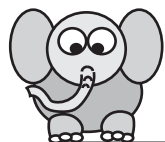

Letter **e** Tracing!

e e



e e e



e e e e



e e e e e e



e e e e e e e

Name: _____

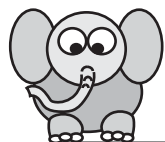

Letter **f** Tracing!

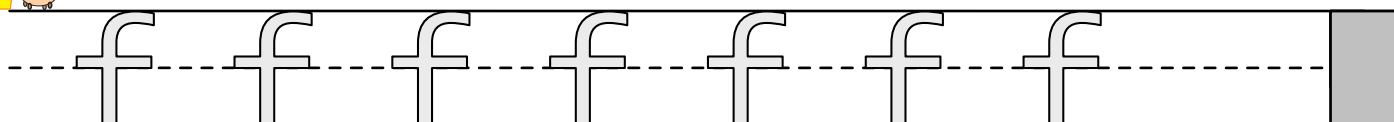
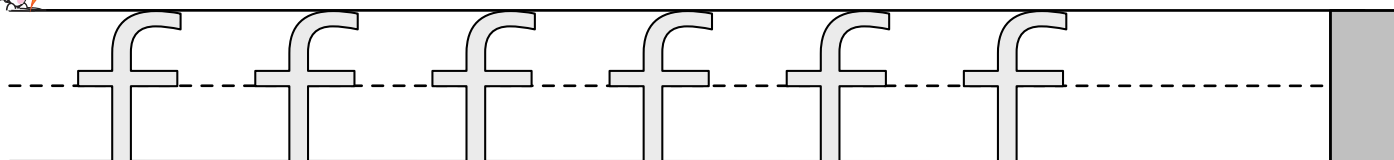
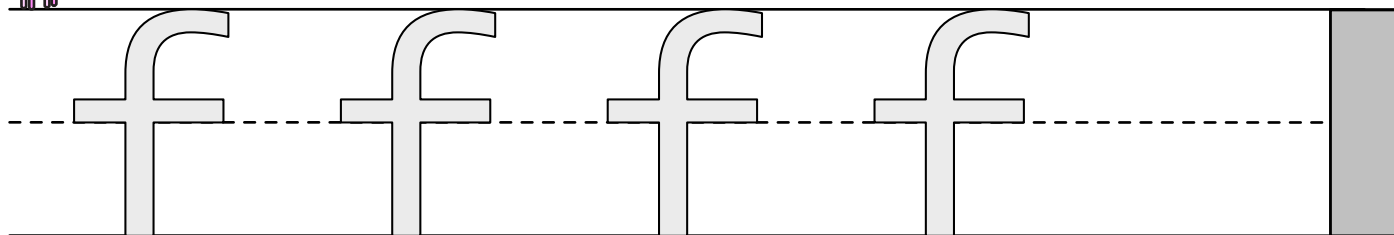
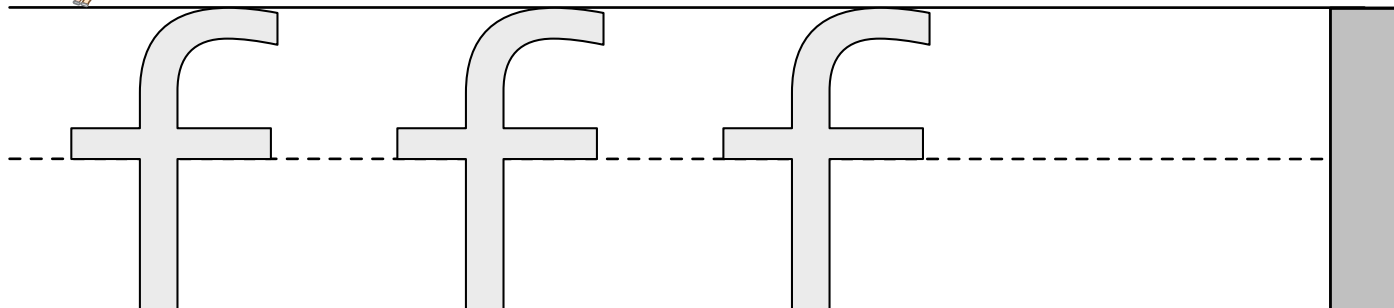
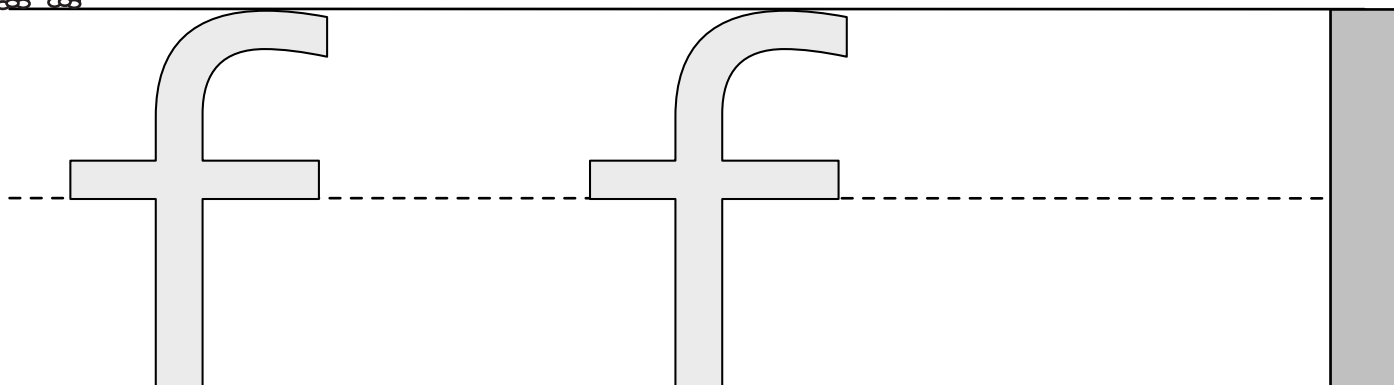

Name: _____

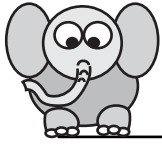

Letter **g** Tracing!

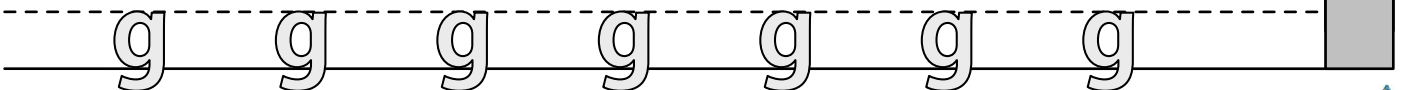
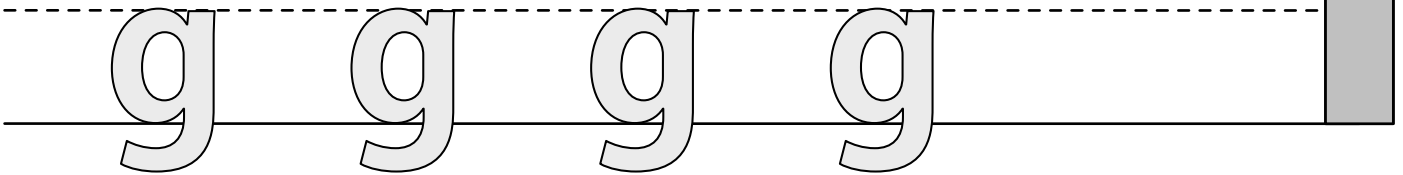
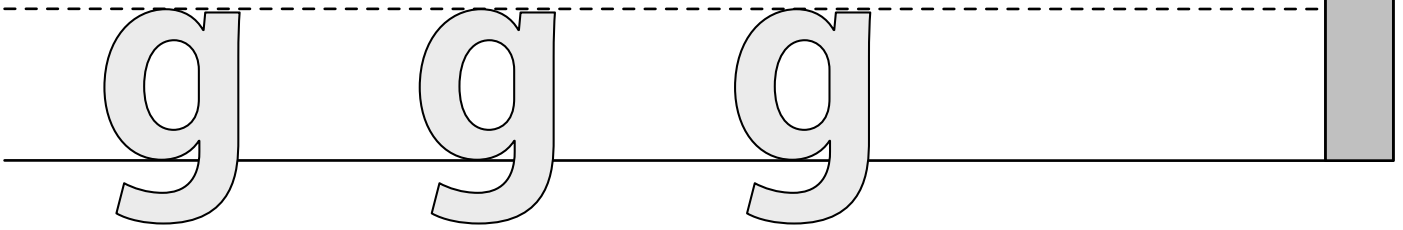
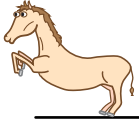
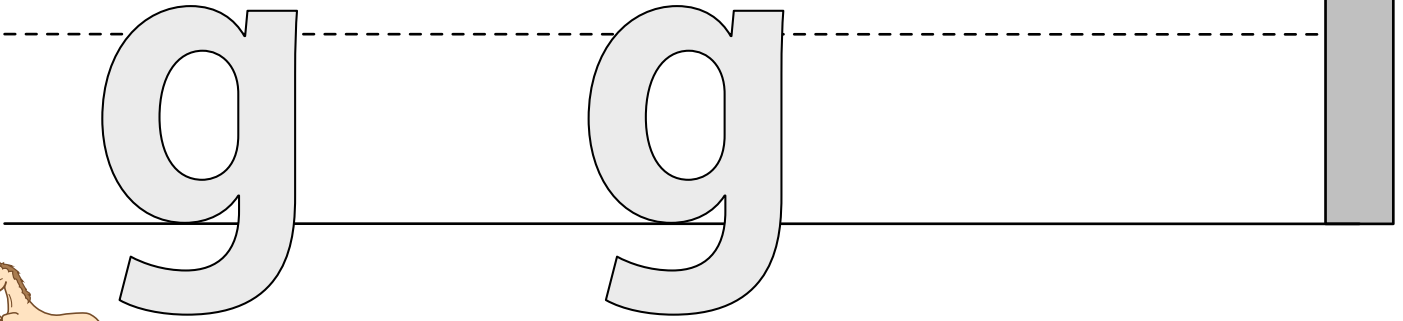

Name: _____

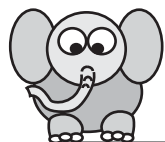

Letter **h** Tracing!

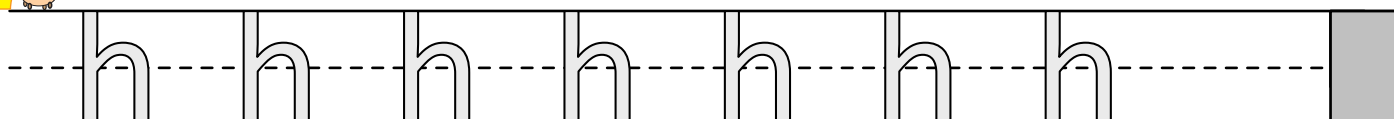
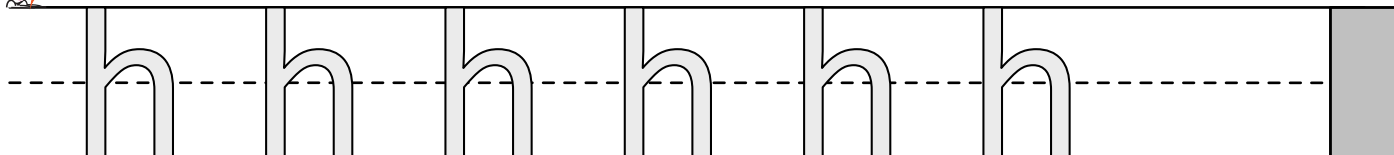
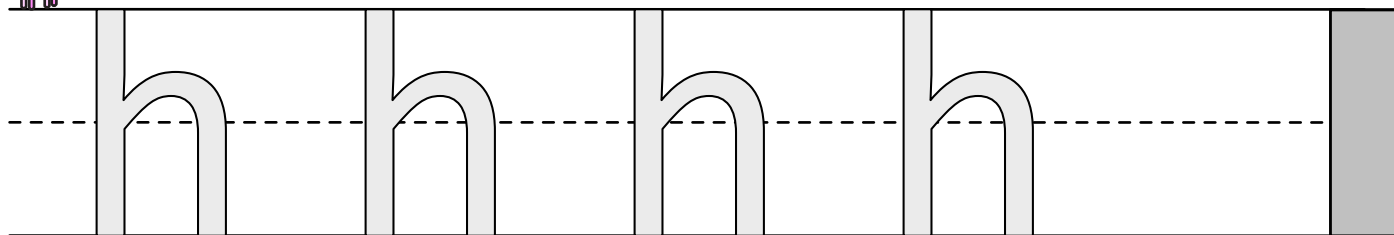
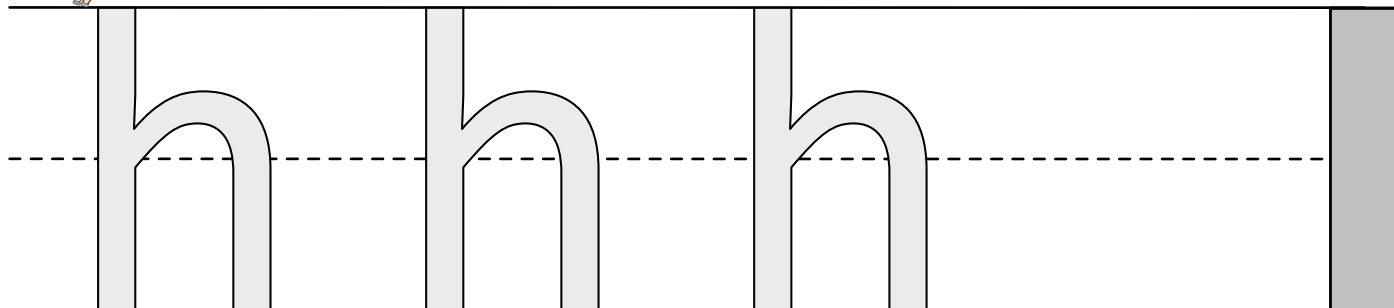
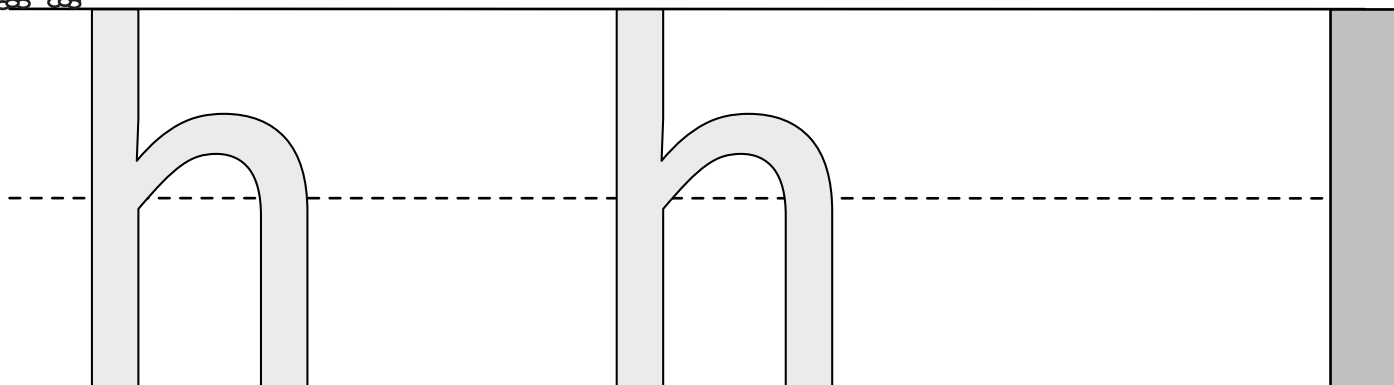

Name: _____

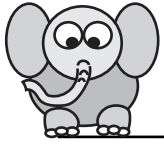

Letter **i** Tracing!

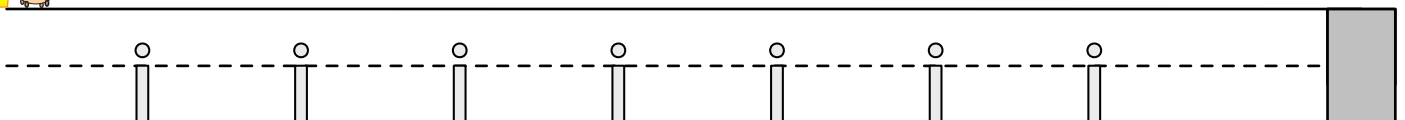
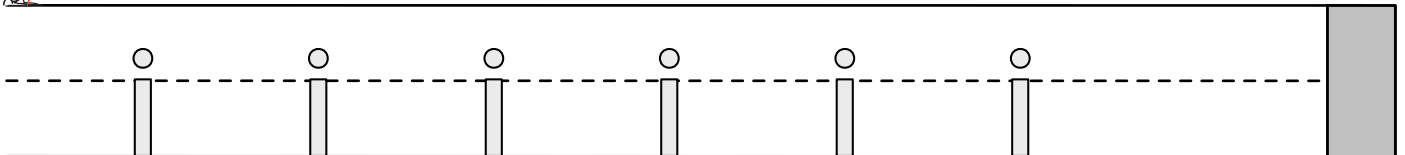
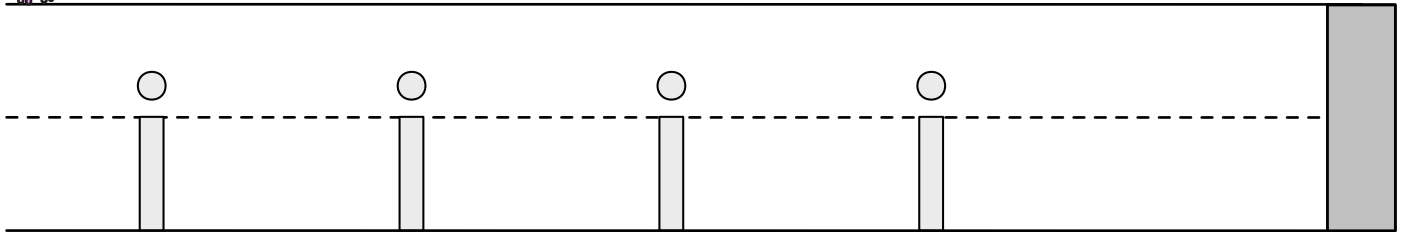
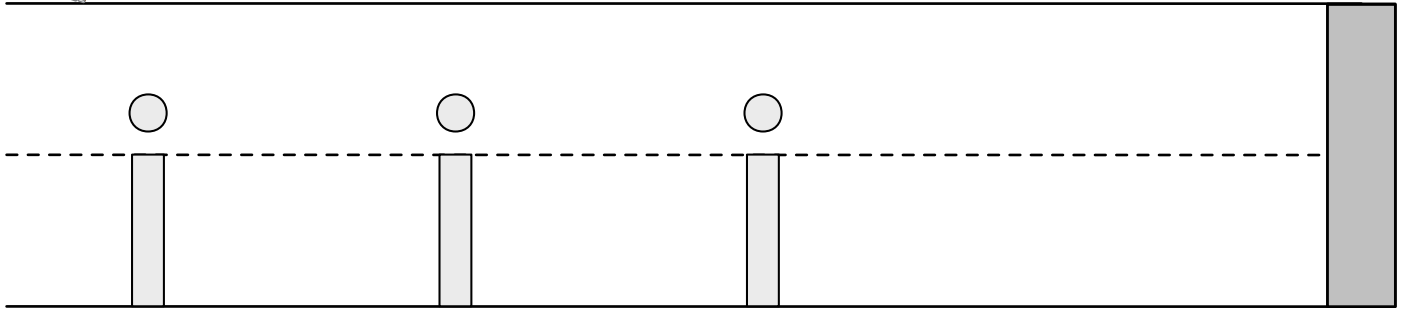
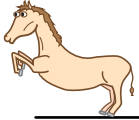
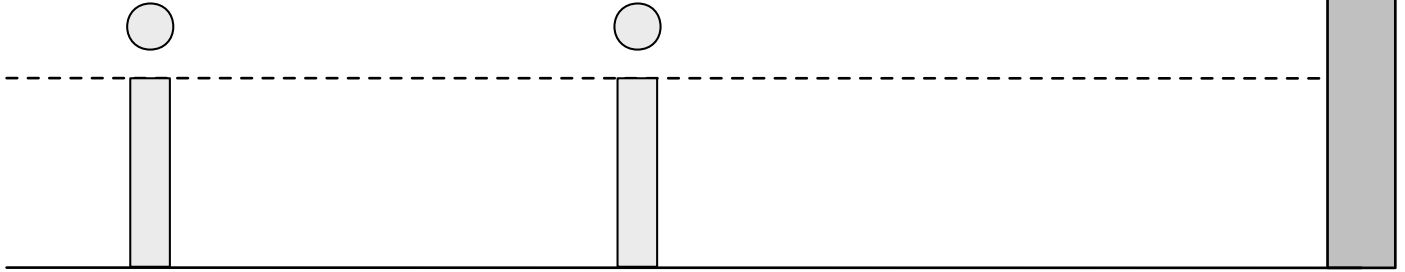

Name: _____

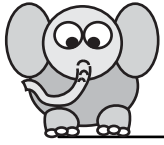

Letter **j** Tracing!

Tracing practice row 1: Two large lowercase 'j' characters on a three-line grid. The first 'j' is light grey with a grey dot above it. The second 'j' is light grey with a grey dot above it. A small illustration of a brown horse is on the left.

Tracing practice row 2: Three medium-sized lowercase 'j' characters on a three-line grid. Each 'j' has a grey dot above it. A small illustration of a pink pig is on the left.

Tracing practice row 3: Four small lowercase 'j' characters on a three-line grid. Each 'j' has a grey dot above it. A small illustration of a white rabbit holding a carrot is on the left.

Tracing practice row 4: Six very small lowercase 'j' characters on a three-line grid. Each 'j' has a grey dot above it. A small illustration of a brown mouse is on the left.

Tracing practice row 5: Seven tiny lowercase 'j' characters on a three-line grid. Each 'j' has a grey dot above it.

Name: _____

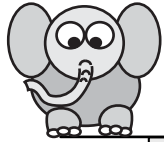

Letter **k** Tracing!

Handwriting row 1: A large uppercase letter 'K' on a set of three lines (top, middle dashed, bottom). The letter is positioned between two vertical grey bars. To the right of the row is a solid grey bar.



Handwriting row 2: Three large uppercase letters 'K' on a set of three lines. Each letter is between two vertical grey bars. A solid grey bar is at the end of the row.



Handwriting row 3: Four large uppercase letters 'K' on a set of three lines. Each letter is between two vertical grey bars. A solid grey bar is at the end of the row.



Handwriting row 4: Six large uppercase letters 'K' on a set of three lines. Each letter is between two vertical grey bars. A solid grey bar is at the end of the row.



Handwriting row 5: Seven large uppercase letters 'K' on a set of three lines. Each letter is between two vertical grey bars. A solid grey bar is at the end of the row.

Name: _____

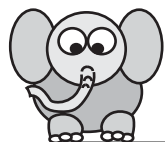

Letter



Tracing!









Name: _____

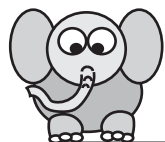

Letter **m** Tracing!

m m



m m m



m m m m



m m m m m m



m m m m m m m

Name: _____

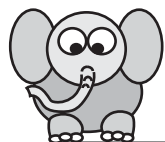

Letter **n** Tracing!

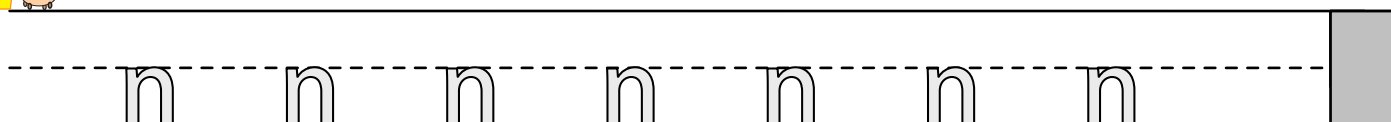
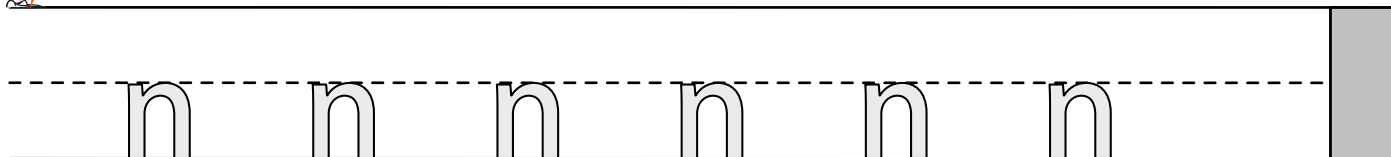
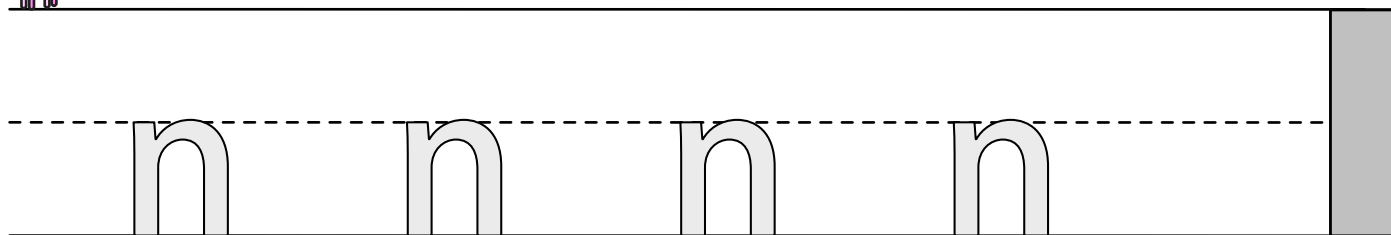
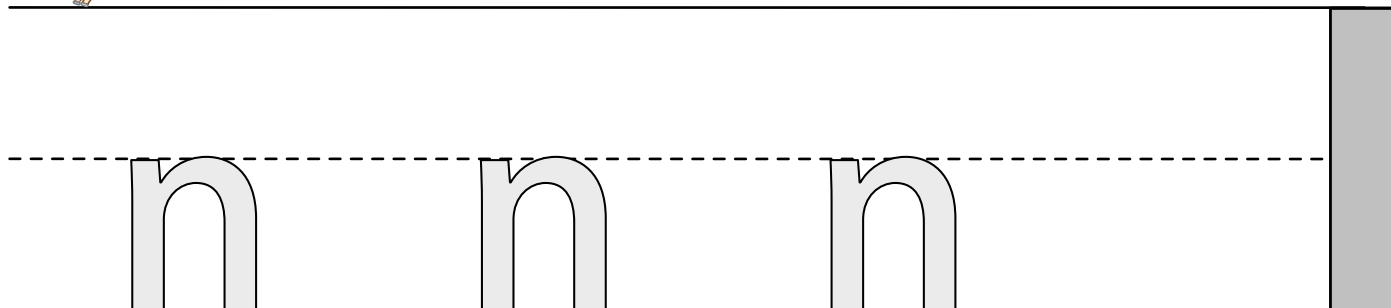
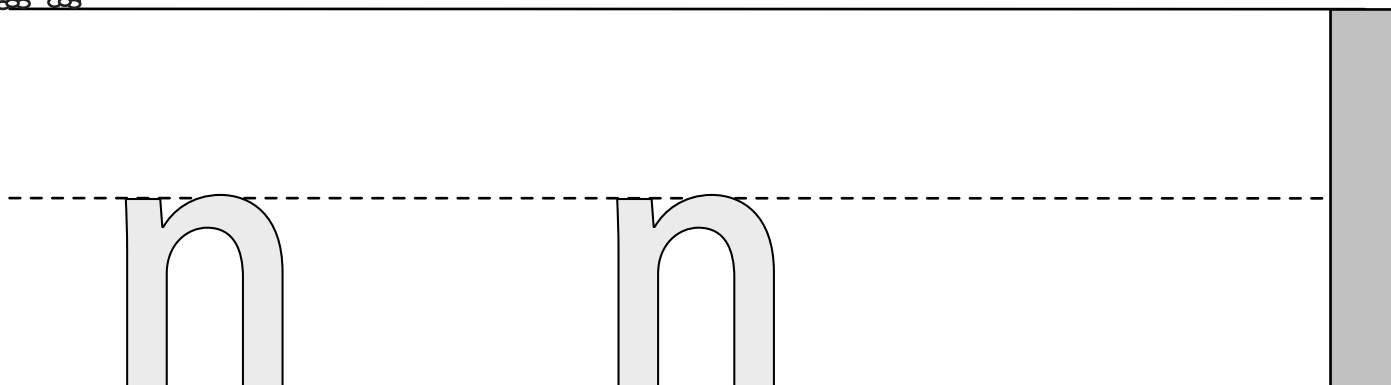

Name: _____

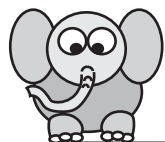

Letter **O** Tracing!

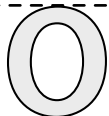
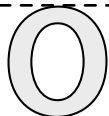
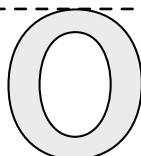
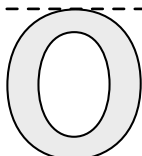
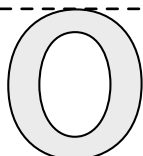
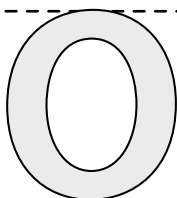
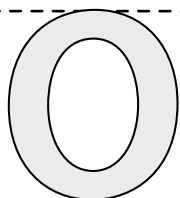

Name: _____

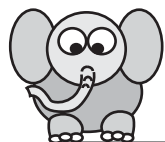

Letter **p** Tracing!

p p



p p p



p p p p



p p p p p p



p p p p p p p

Name: _____

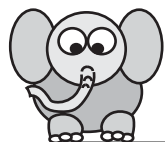

Letter **q** Tracing!

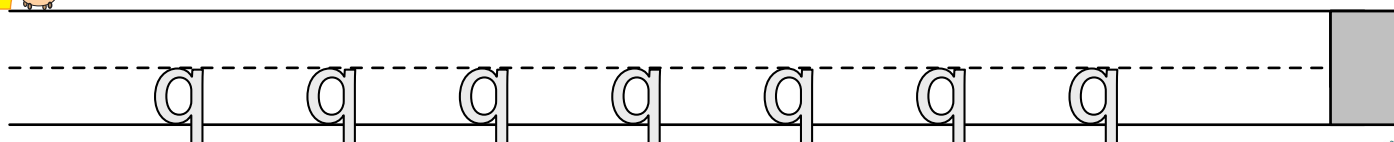
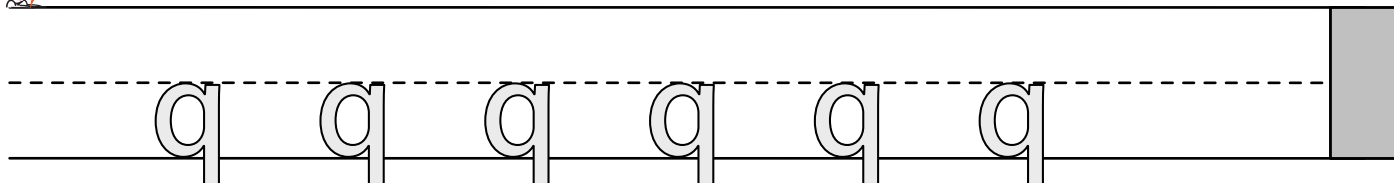
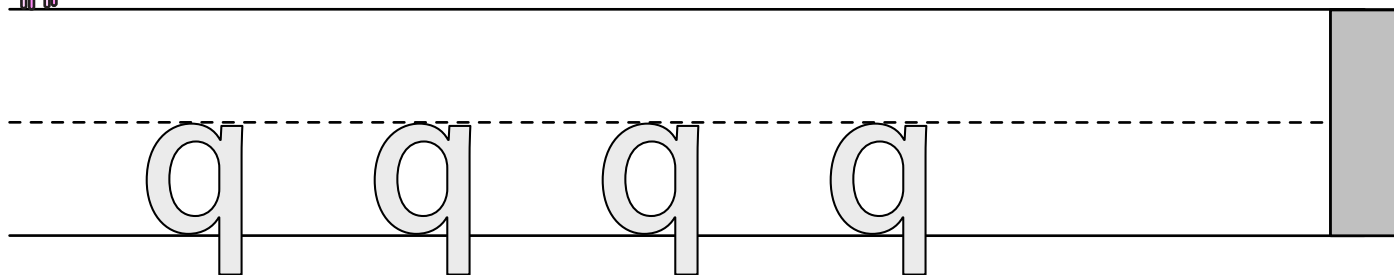
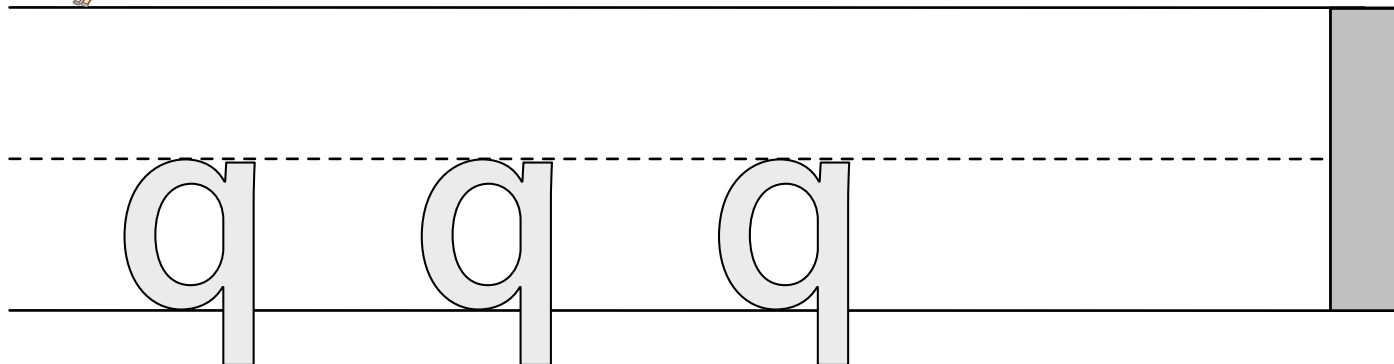
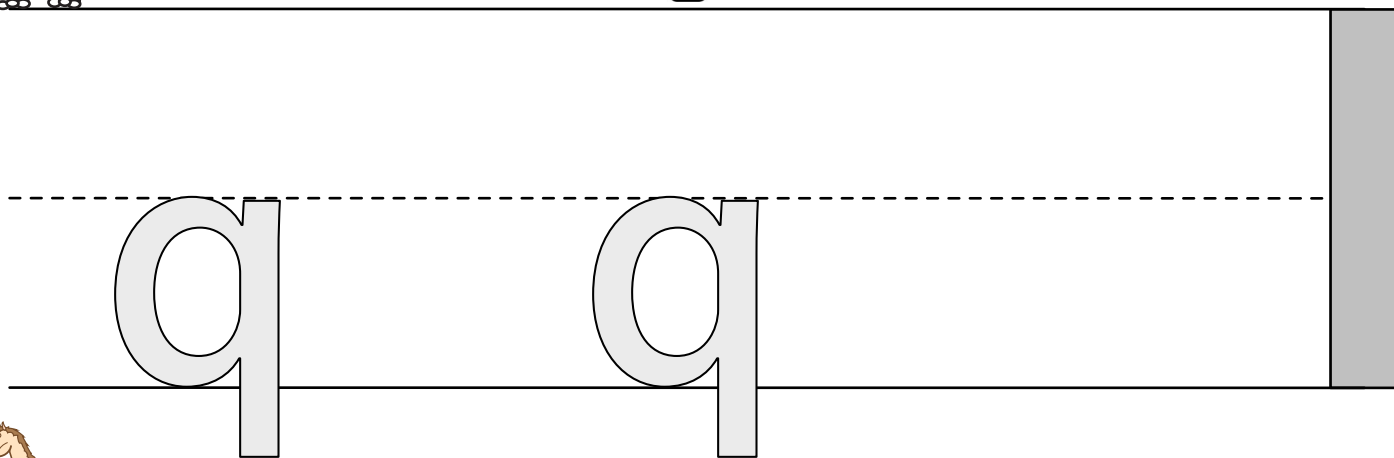

Name: _____

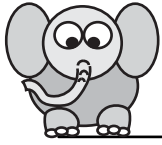

Letter Tracing!

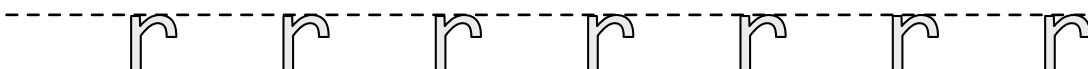
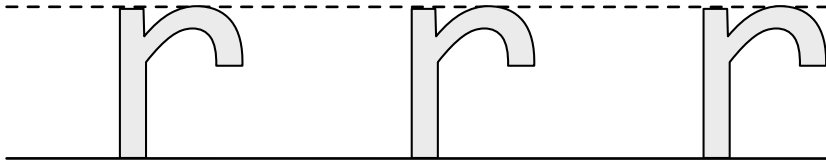
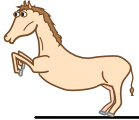
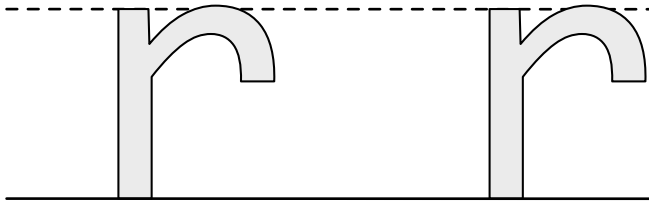

Name: _____

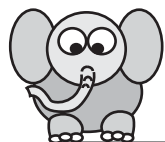

Letter **S** Tracing!

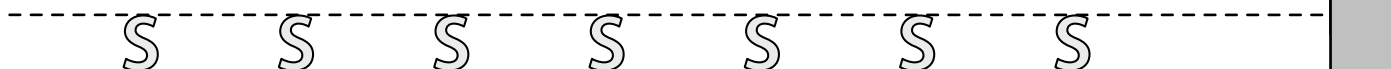
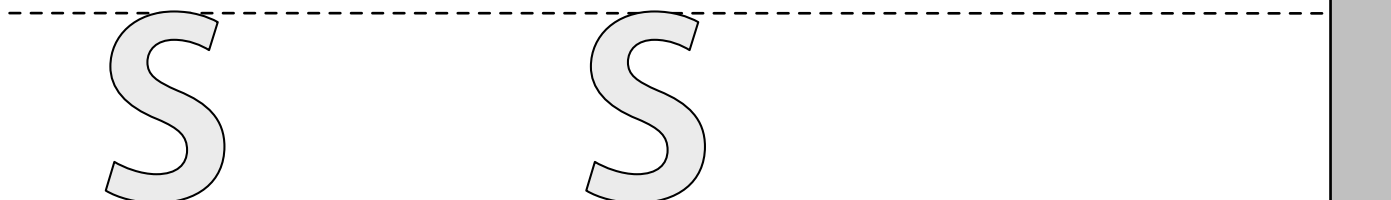

Name: _____

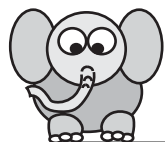

Letter Tracing!

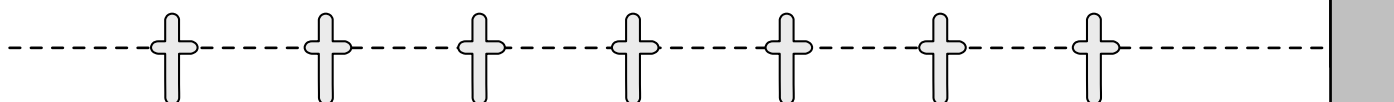
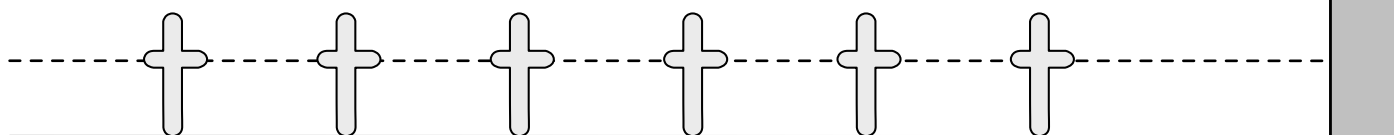
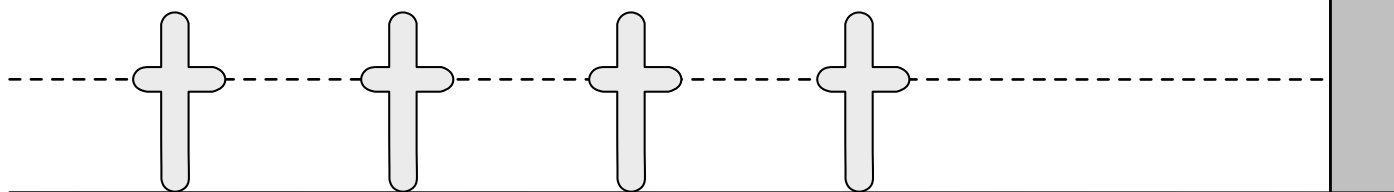
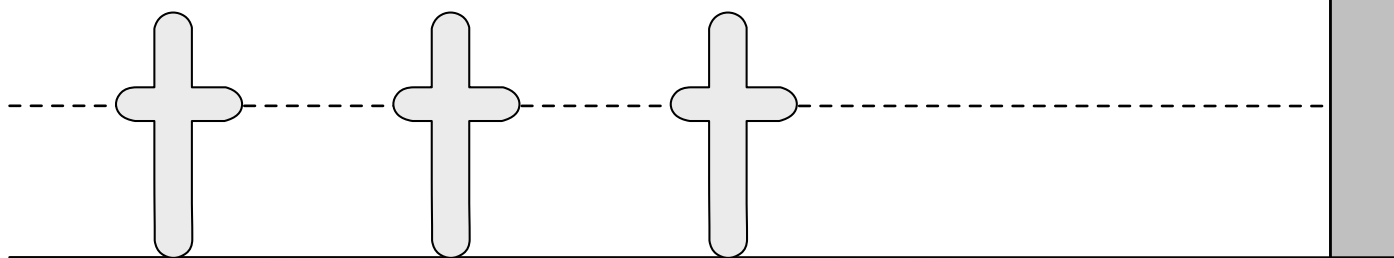
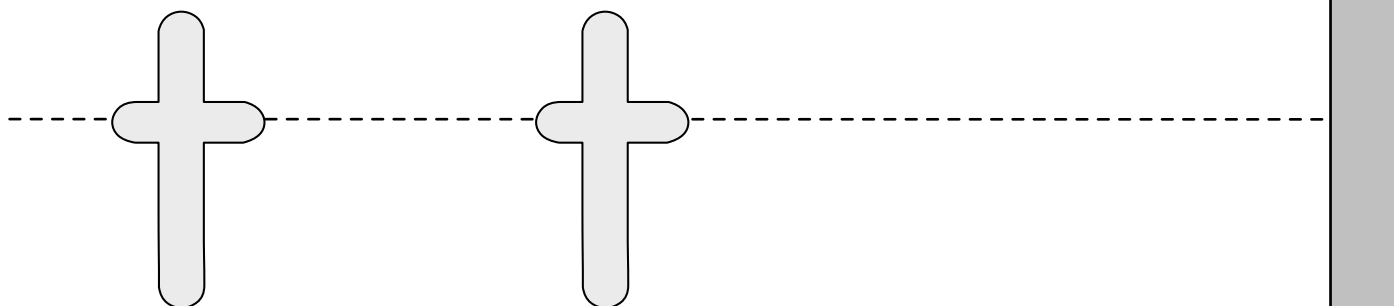

Name: _____

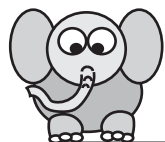

Letter **U** Tracing!

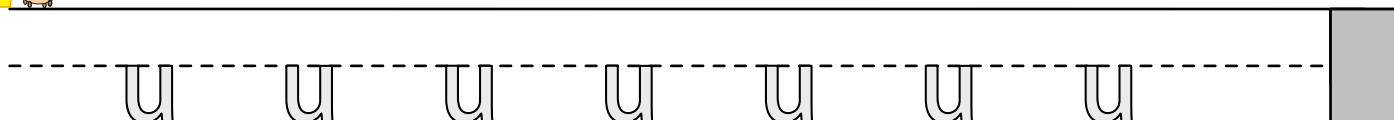
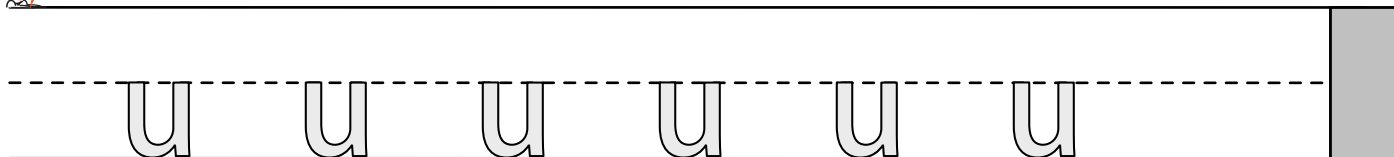
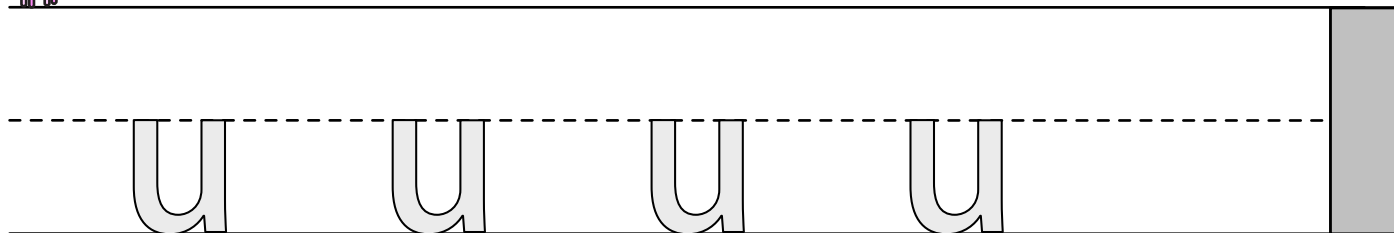
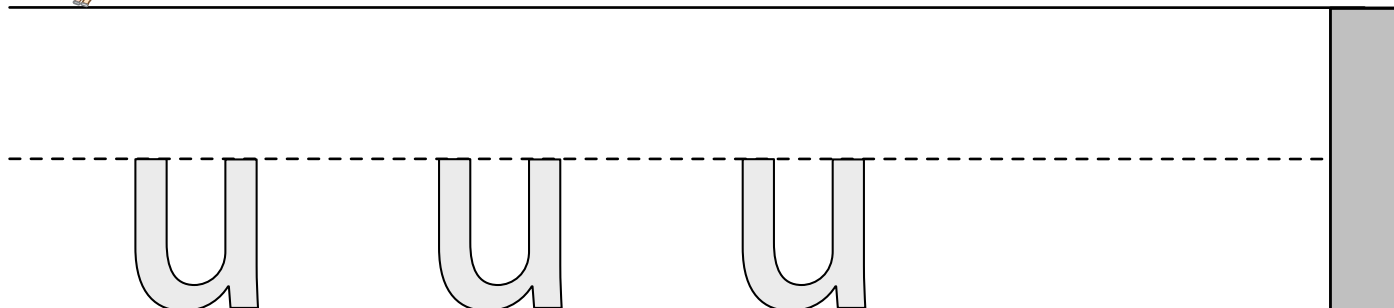
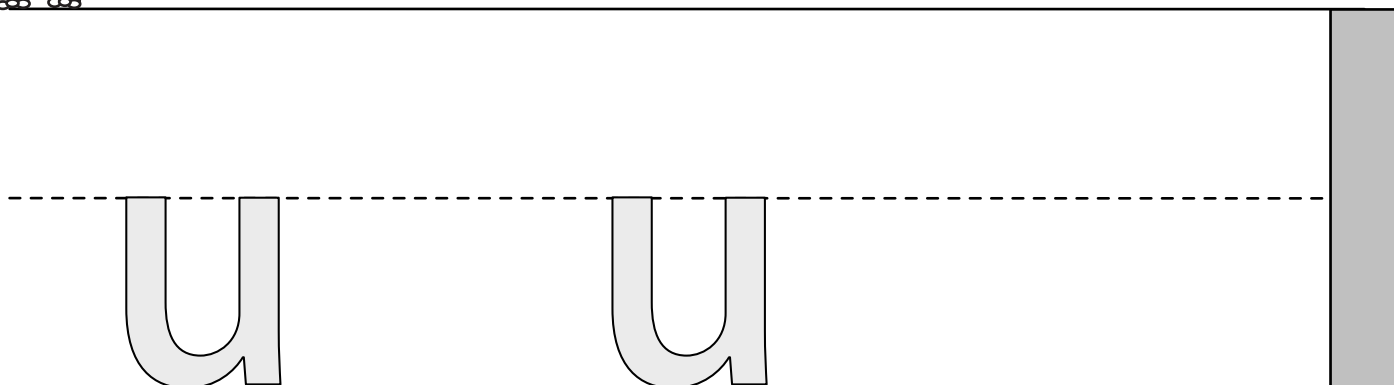

Name: _____

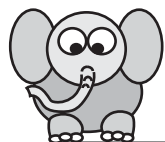

Letter **V** Tracing!

Tracing row 1: A horizontal line with a dashed midline and a solid bottom line. Two large, light grey uppercase 'V' characters are positioned between the lines for tracing. A grey vertical bar is on the right side.



Tracing row 2: A horizontal line with a dashed midline and a solid bottom line. Three medium-sized, light grey uppercase 'V' characters are positioned between the lines for tracing. A grey vertical bar is on the right side.



Tracing row 3: A horizontal line with a dashed midline and a solid bottom line. Four small, light grey uppercase 'V' characters are positioned between the lines for tracing. A grey vertical bar is on the right side.



Tracing row 4: A horizontal line with a dashed midline and a solid bottom line. Six very small, light grey uppercase 'V' characters are positioned between the lines for tracing. A grey vertical bar is on the right side.



Tracing row 5: A horizontal line with a dashed midline and a solid bottom line. Seven tiny, light grey uppercase 'V' characters are positioned between the lines for tracing. A grey vertical bar is on the right side.

Name: _____

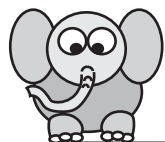

Letter **W** Tracing!

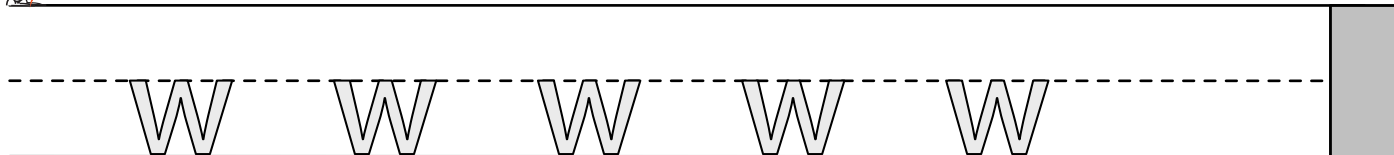
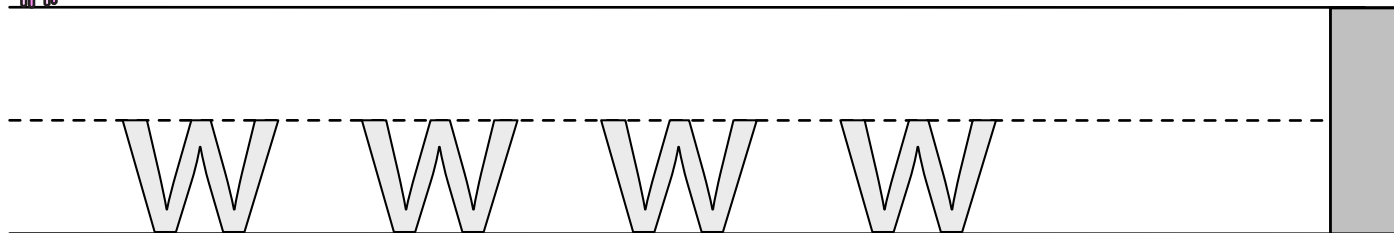
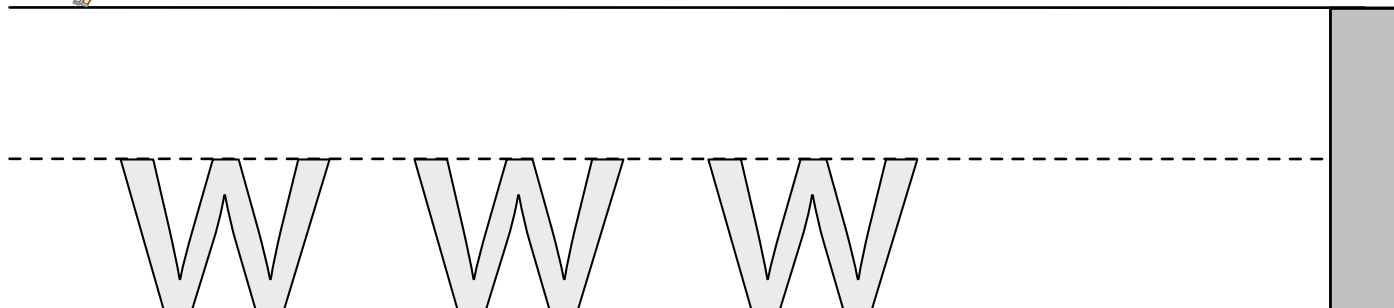
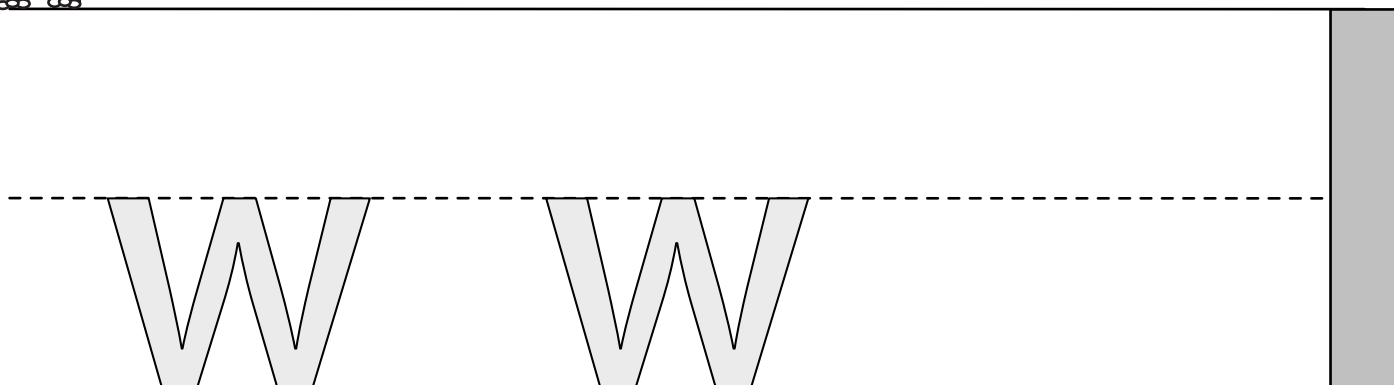

Name: _____

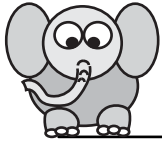

Letter **X** Tracing!

X X

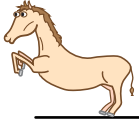

X X X



X X X X



X X X X X X



X X X X X X X

Name: _____

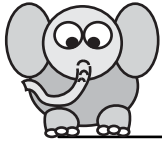

Letter **Y** Tracing!

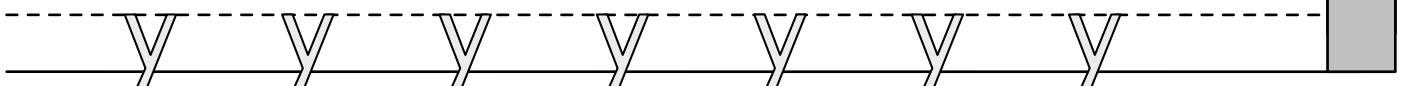
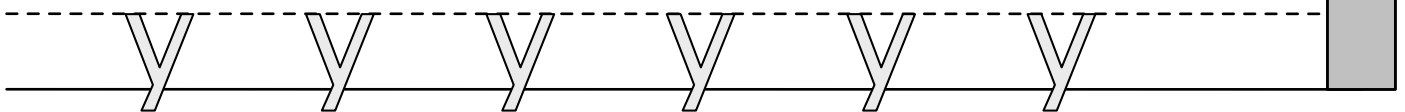
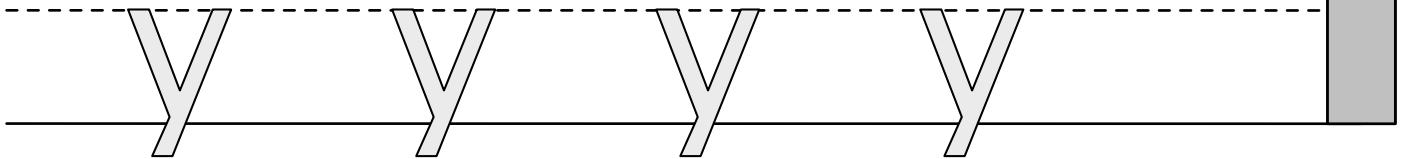
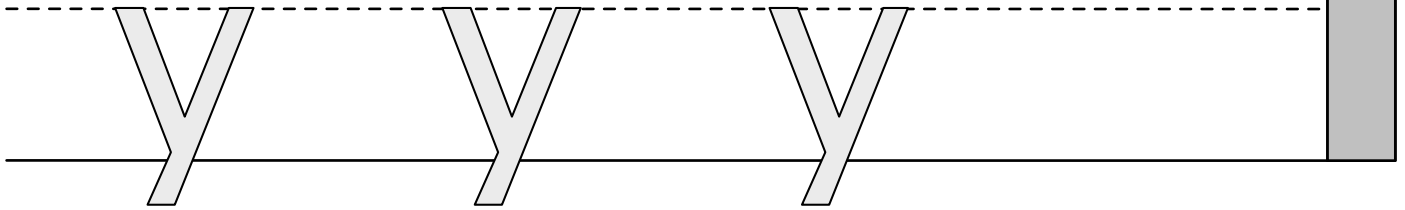
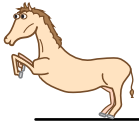
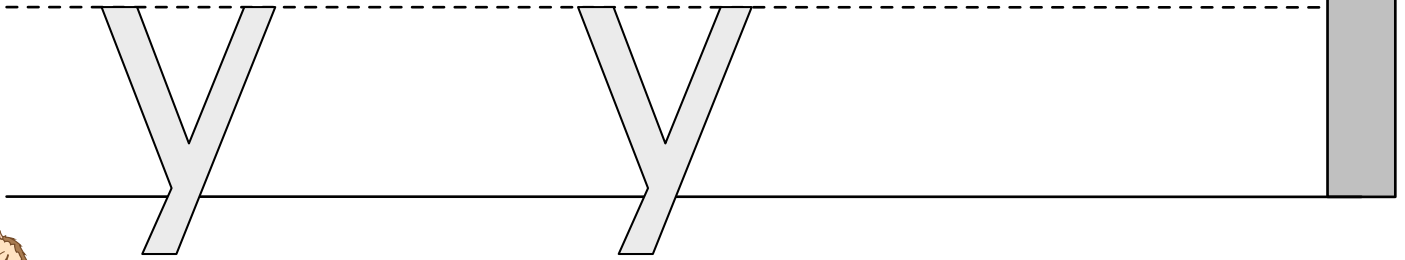

Name: _____

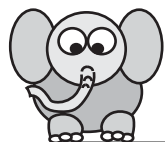

Letter **Z** Tracing!

